

FENDER CATALOG



ROAD CHOICE



We are committed to keeping trucks on the road and moving forward by providing quality parts to all who repair heavy-duty vehicles.

CONFIDENCE.
COVERAGE.
COMMITMENT.

TABLE OF CONTENTS

SINGLE AXLE FENDERS

Wide-Based Tire	4
Smooth Series	4
Poly	4
Single Axle Fender Mounting Kits	5

HALF TANDEM FENDERS

Smooth Series	6
Poly	6
Ribbed	7
Half Tandem Fender Mounting Kits	7

FULL TANDEM FENDERS

Wide-Based Tire	8
Smooth Series	8
Poly	8
Poly Roll-Off	9
Full Tandem Fender Mounting Kits	9

FENDER MOUNTING COMPONENTS . . . 10

QUARTER FENDERS

Wide-Based Tire	11
Poly	11
Full Brace	11
Half Brace	12
Braceless	12

MUD FLAP HANGERS

Conspicuity	13
Angled Conspicuity	13
Non-Conspicuity	15
Angled Non-Conspicuity	15

CROSS-REFERENCE . . . 16



**Parts that keep you moving.
Quality that keeps you coming back.**

SINGLE AXLE FENDERS

WIDE-BASED TIRE

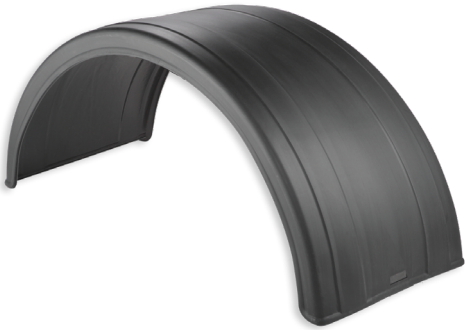

SAF500077P

- One black corrosion- and UV-resistant polyethylene fender
- Overall Length: 75"
- Width: 19"
- Weight: 16 lbs.

Note: Use mounting kit SAF4055MK or SAF4005MK on page 5.

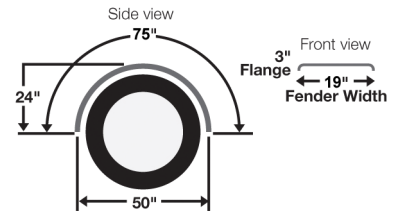

SMOOTH SERIES



SAF370580S

- One 16-gauge stainless steel fender
- Overall Length: 80"
- Width: 24"
- Weight: 35 lbs.

Note: Use mounting kit SAF4000MK on page 5.

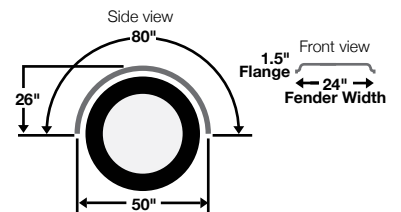

POLY



SAF500576P

- One black corrosion- and UV-resistant polyethylene fender
- Overall Length: 76"
- Width: 24"
- Weight: 10.5 lbs.

Note: Use mounting kit SAF4055MK or SAF4005MK on page 5.

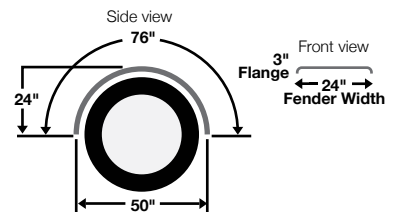

SINGLE AXLE FENDERS

SINGLE AXLE FENDER MOUNTING KITS

All kits mount a pair of fenders.

SAF4000MK



SAF4005MK



SAF4055MK



HALF TANDEM FENDERS

SMOOTH SERIES



HTF372560S

- One 16-gauge stainless steel fender
- Overall Length: 60"
- Width: 24"
- Weight: 26 lbs.

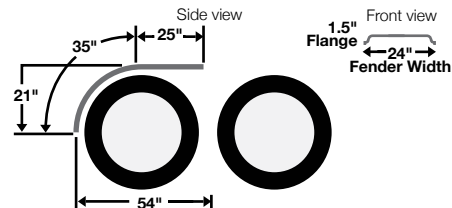

HTF372566S

- One 16-gauge stainless steel fender
- Overall Length: 66"
- Width: 24"
- Weight: 29 lbs.

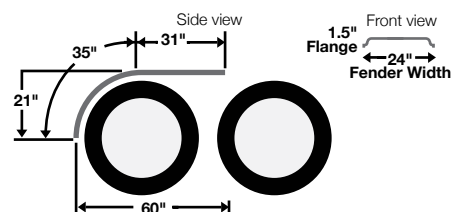

Note: Use mounting kit
HTF4200MK with FMC16501
and FMC16502 on page 7.

POLY



HTF532566P

Volvo PDC part number: 23900900

- One black corrosion- and UV-resistant polyethylene fender
- Overall Length: 66"
- Width: 24"
- Weight: 11 lbs.

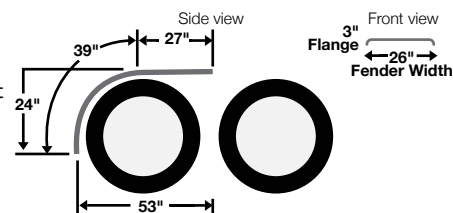

Note: Use mounting kit HTF4235XMK
or HTF4255XMK on page 7.

HALF TANDEM FENDERS

FLANGED 3 RIB



HTF332560S

- One 16-gauge stainless steel fender
- Overall Length: 60"
- Width: 24"
- Weight: 26 lbs.

Note: Use mounting kit HTF4200MK listed below with FMC16501 and FMC16502 on page 10.

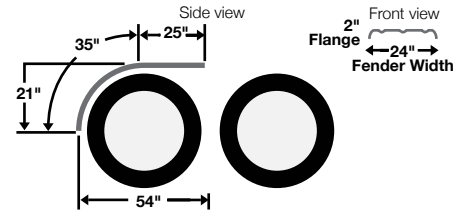

4 RIB



HTF362560S

- One 18-gauge stainless steel fender
- Overall Length: 60"
- Width: 24"
- Weight: 22 lbs.

Note: Use mounting kit HTF4200MK listed below with FMC16501 and FMC16502 on page 10.

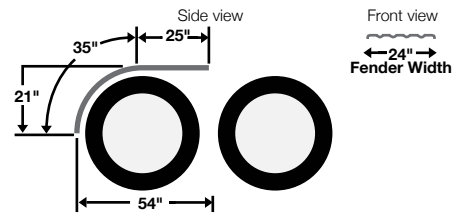

HALF TANDEM FENDER MOUNTING KITS

All kits mount a pair of fenders.

HTF4200MK*

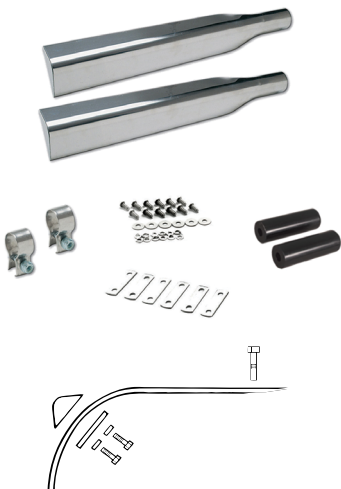

HTF4235XMK

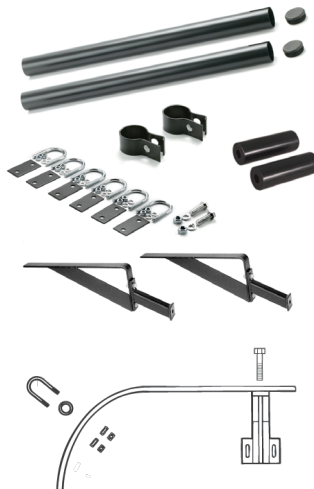

HTF4255XMK

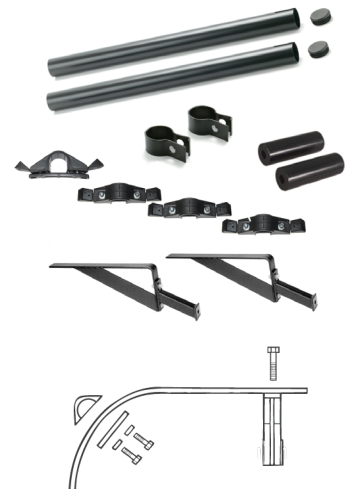

*Rear brackets must be ordered separately. See part numbers FMC16501 and FMC16502 on page 10.

FULL TANDEM FENDERS

WIDE-BASED TIRE



FTF5040131P

- One black corrosion- and UV-resistant polyethylene fender
- Overall Length: 131"
- Width: 19"
- Weight: 25 lbs.

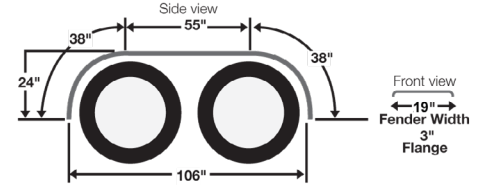

Note: Use mounting kit SAF4005MK or SAF4055MK from page 5 along with FMC16501 and FMC16502 on page 10.

SMOOTH SERIES



FTF3745120S

- One 16-gauge stainless steel fender
- Overall Length: 120"
- Width: 24"
- Weight: 53 lbs.

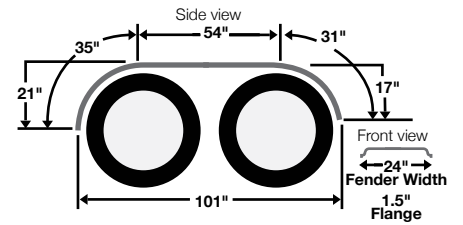

Note: Use mounting kit FTF4400MK with FMC16501 and FMC16502 on page 9.

POLY



FTF5345131P

- One black corrosion- and UV-resistant polyethylene fender
- Overall Length: 131"
- Width: 26"
- Weight: 24 lbs.

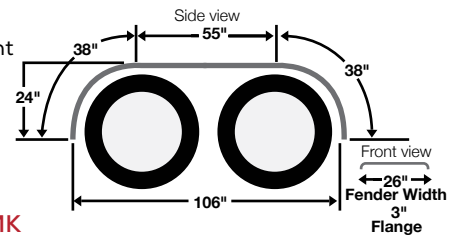

Note: Use mounting kit FTF4435XMK or FTF4455XMK on page 9.

FULL TANDEM FENDERS

POLY ROLL-OFF



Note: Two pieces connect to form a full tandem.

FTF7125P

- One black corrosion- and UV-resistant polyethylene fender
- Overall Length: 46"
- Width: 25"
- Weight: 23 lbs.

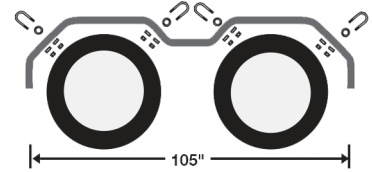

Note: Use mounting kit FTF4435XMK listed below.

TRI-AXLE EXTENDER



FTF72251P

- One black corrosion- and UV-resistant polyethylene fender extender
- Overall Length: 46"
- Width: 25"
- Weight: 10 lbs.

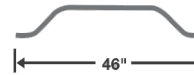

Parts shown:
FTF7125P and
FTF72251P

FULL TANDEM FENDER MOUNTING KITS

All kits mount a pair of fenders.

FTF4400MK*

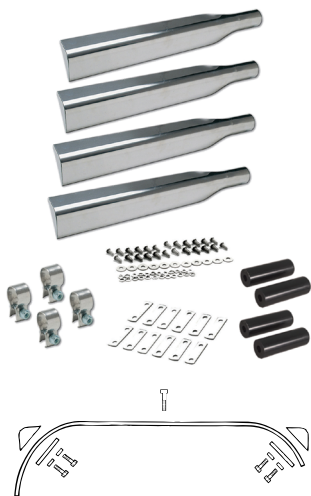

FTF4435XMK



FTF4455XMK



*Rear brackets must be ordered separately. See part numbers FMC16501 and FMC16502 on page 10.

FENDER MOUNTING COMPONENTS

CENTER MOUNTING BRACKETS



FMC160018M

- Universal
- 8" post mount
- Bolt not provided



FMC16501

- Universal – left hand
- Height: 8 1/2" – 11 5/8"
- No plate
- Single hole



FMC16502

- Universal – right hand
- Height: 8 1/2" – 11 5/8"
- No plate
- Single hole



FMC16507

- Wide-based tire application – left hand
- Height: 8 1/2" – 11 5/8"
- No plate
- Single hole



FMC16508

- Wide-based tire application – right hand
- Height: 8 1/2" – 11 5/8"
- No plate
- Single hole



FMCFL360

- Adjustable 360 swivel fender mount
- Height: 8" with 27" to 30" length adjustment
- One bolt installation

QUARTER FENDERS

POLY



QF1900 (Set of two)

Volvo PDC part number: 23900898

- Black corrosion- and UV-resistant polyethylene fenders
- One left-hand fender
- One right-hand fender
- Two top flaps with hardware
- Two clamps
- Length: 24"
- Weight: 20 lbs. (pair)

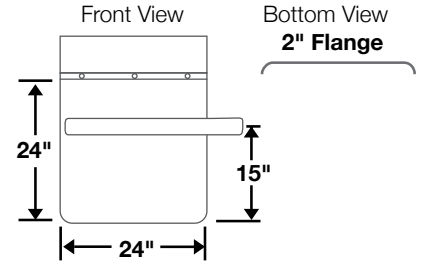

Also available in bulk:

QF1900BULK16 (Single fender)

Volvo PDC part number: 23900897

- Unassembled single quarter fender
- Can be assembled as left hand or right hand
- Top flap, clamp and hardware included

Minimum order quantity of 16

FULL BRACE



QF1585FB (Set of two)

- 18-gauge stainless steel fenders
- One left-hand fender
- One right-hand fender
- Two top flaps with hardware
- Two stainless steel clamps
- Length: 22"
- Weight: 32 lbs. (pair)

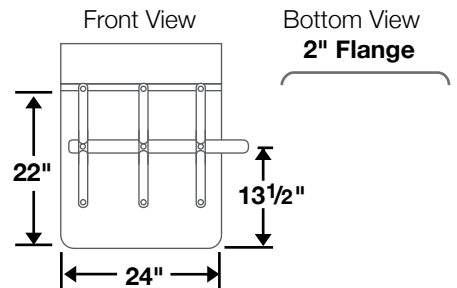

QUARTER FENDERS

HALF BRACE



QF1585LM (Set of two)

- Two 18-gauge stainless steel fenders
- Extended clearance low mount
- One left-hand fender
- One right-hand fender
- Two top flaps with hardware
- Two stainless steel clamps
- Length: 22"
- Weight: 29 lbs. (pair)

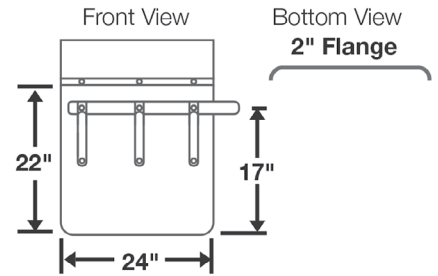

QF1585HB (Set of two)

- Two 18-gauge stainless steel fenders
- One left-hand fender
- One right-hand fender
- Two top flaps with hardware
- Two stainless steel clamps
- Length: 22"
- Weight: 30 lbs. (pair)

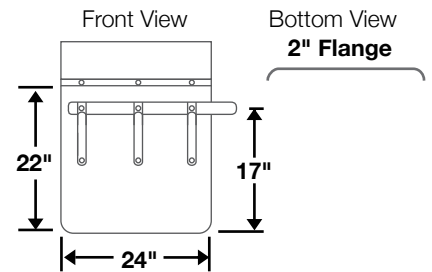

BRACELESS



QF1585B (Set of two)

Volvo PDC part number: 23900899

- Two 18-gauge stainless steel fenders
- One left-hand fender
- One right-hand fender
- Two top flaps with hardware
- Two stainless steel clamps
- Length: 22"
- Weight: 29 lbs. (pair)

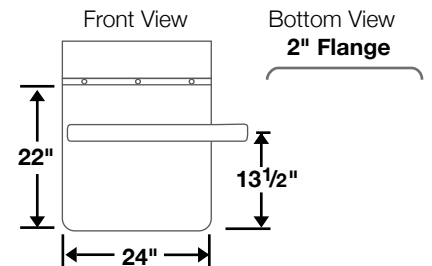

Also available in bulk:

QF1585BBULK16 (Single fender)

- Unassembled single quarter fender
- Can be assembled as left hand or right hand
- Top flap, clamp and hardware included

Minimum order quantity of 16

MUD FLAP HANGERS

Mounting hardware is included on all mud flap hangers

CONSPICUITY MUD FLAP HANGER

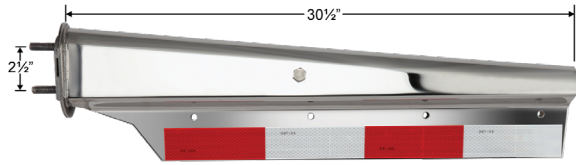

MFB30SSCX (Set of two)

- Stainless steel
- Weight: 20 lbs.
- Length: 30.5"



MFBBF30SSCX (Set of two)

- Stainless steel
- Weight: 20 lbs.
- Length: 30"



MFB30PCX (Set of two)

- Painted black
- Weight: 20 lbs.
- Length: 30"



MFB31PCX (Set of two)

- Painted black
- Weight: 20 lbs.
- Length: 31.5"



MFB31SSCX (Set of two)

- Stainless steel
- Weight: 20 lbs.
- Length: 31.5"

ANGLED CONSPICUITY MUD FLAP HANGERS



MFB3045PCX (Set of two)

- Painted black
- Weight: 18 lbs.
- Length: 27"



MFB3045SSCX (Set of two)

- Stainless steel
- Weight: 19 lbs.
- Length: 27"

MUD FLAP HANGERS

Mounting hardware is included on all mud flap hangers

ANGLED CONSPICUITY MUD FLAP HANGERS (CONTINUED)

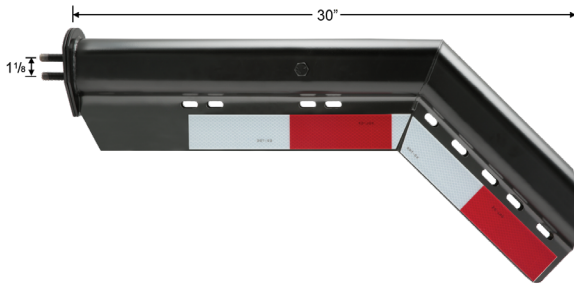

MFB3345PCX (Set of two)

- Painted black
- Weight: 20 lbs.
- Length: 30"

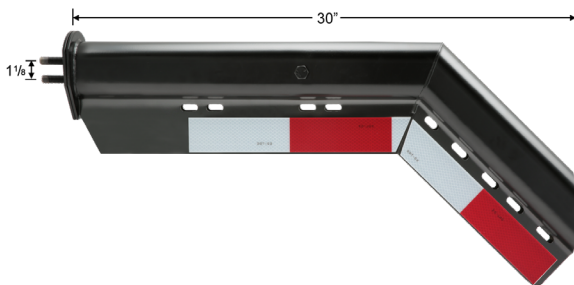

MFB3145PCX (Set of two)

- Painted black
- Weight: 20 lbs.
- Length: 31.5"



MFB3145SSCX (Set of two)

- Stainless steel
- Weight: 20 lbs.
- Length: 31.5"



MFB3345SSCX (Set of two)

- Stainless steel
- Weight: 20 lbs.
- Length: 30"

MUD FLAP HANGERS

Mounting hardware is included on all mud flap hangers

NON-CONSPICUITY MUD FLAP HANGERS



MFB30P (Set of two)

- Painted black
- Length: 30"



MFB30SS (Set of two)

- Stainless steel
- Length: 30"



MFB28P (Set of two)

- Painted black
- Weight: 17 lbs.
- Length: 28"



MFB28SS (Set of two)

- Stainless steel
- Weight: 17 lbs.
- Length: 28"

ANGLED NON-CONSPICUITY MUD FLAP HANGERS



MFB3045P (Set of two)

- Painted black
- Weight: 17 lbs.
- Length: 27"



MFB3045SS (Set of two)

- Stainless steel
- Weight: 17 lbs.
- Length: 27"

FENDER CROSS-REFERENCE

QUARTER FENDERS

PART NUMBER	VOLVO PDC PART NUMBER	BETTS	FLEET ENGINEERS	MINIMIZER
QF1900	23900898	PS214PA2	031-01636	MIN1400
QF158531WT			031-01635	
QF1585LM		SS222PA2	031-01074	
QF1585B	23900899	SS212PA2	031-01070	
QF1585HB		PS221PA2		

SINGLE AXLE FENDERS

PART NUMBER	VOLVO PDC PART NUMBER	BETTS	FLEET ENGINEERS	MINIMIZER
SAF500576P		PF200-80-1	034-02464 031-01520	MIN2480 (PM2481),* MIN2260 (PM2261)
SAF500077P		PF100-60-1	034-02130	MIN1600 (PM1601),* MIN1900 (PM1901), MIN221800 (PM2218)
SAF370580S		TSA28000000	034-02241	

HALF TANDEM FENDERS

PART NUMBER	VOLVO PDC PART NUMBER	BETTS	FLEET ENGINEERS	MINIMIZER
HTF342072WT			034-02212	
HTF532566P	23900900	PF300-66-1	034-02190, 034-02194, 034-02198	MIN950 (PM901),* MIN1550 (PM1501), MIN950 (PM4001)
HTF362560S		SR300-60-1	034-01320	
HTF372560S		TSB3902700		
HTF372566S		TSB3503100	034-02240	

FULL TANDEM FENDERS

PART NUMBER	VOLVO PDC PART NUMBER	BETTS	FLEET ENGINEERS	MINIMIZER
FTF7125P				MIN200 (PM201)
FTF72251P				MIN300 (PM2014)
FTF5345131P		PF400-132X	031-01639, 031-01646	MIN900 (PM901),* MIN1500 (PM1501), MIN1554 (PM1554), MIN4000 (PM4001)
FTF3745120S		TSC3505431	034-00443	

MISCELLANEOUS

PART NUMBER	VOLVO PDC PART NUMBER	BETTS	FLEET ENGINEERS	MINIMIZER
FMC16501		B900S	034-00866	
FMC16502		B900S	034-00866	
FMC1600005B		SF100H		

MUD FLAP HANGER BRACKETS

PART NUMBER	VOLVO PDC PART NUMBER	BETTS	FLEET ENGINEERS	MINIMIZER
MFB30SS		B70300NTSK	033-00870, 033-04993	
MFB30P		B70300NTBK	033-00868, 033-04992	
MFB30SSCX		B80300RTSK	033-04550, 033-05193	
MFB3045P		B672625NTBK	033-00864	
MFB3045SSCX		B673025WTSK	033-04648, 033-05197	
MFB3045PCX		B672625WTBK	033-04542, 033-05194	
MFB3345PCX		B673025WTBK	033-04546, 033-04647, 033-05196	

MOUNTING KITS

PART NUMBER	VOLVO PDC PART NUMBER	BETTS	FLEET ENGINEERS	MINIMIZER
SAF4000MK		L200TS	031-02022	
SAF4055MK		K2363UG	031-02000	B100BTSA
HTF4200MK		U300TS	031-02023	
HTF4235XMK		K3363UG	031-02015, 031-02016	B4850BTSA
FTF4400MK		U400TS	031-02027	
FTF4435XMK		K4363UG	031-02008, 031-02044	B4578BTSA

* Closest Match

NOTES



ROAD CHOICE

© 2024 Road Choice® - All Rights Reserved.
RCOFE-22CAT-041224